

DI-1200

12th Generation Intel Core i7/i5/i3 High Performance, Compact and Modular Rugged Embedded Computer

HIGH PERFORMANCE • POWER-SAVING

DI-1200 | Intel Alder Lake-P Compact Rugged Computer

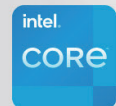

Overview

[CONTACT](#)

The DI-1200, with a 12th generation Intel® Core™ U-series (Alder Lake-P Platform) processor, provides outstanding performance and boasts a low power consumption of 15W. The compact DI-1200 offers rich I/O interfaces and expansion options, meeting the requirements for high-performance, rugged embedded computers used in confined spaces. It suits for industrial automation, warehousing and logistics, transportation, environmental monitoring, and IoT applications.

Key Features

- Onboard 12th Intel® Alder Lake-P U-Series Core™ i7/i5/i3 Processors
- 1 x DDR5 SO-DIMM Sockets, Supports up to 4800MHz 32GB Memory
- Quad Independent Display (2x DP/HDMI/CMI Display)
- 1x M.2 Key E Type 2230 Socket for Wireless/Intel CNVi Module Expansion
- 1x M.2 Key B Type 3042/3052 Socket for 5G/Storage/Add-on Card Expansion
- CMI Technology for Optional I/O Module Expansions
- CFM Technology for Power Ignition Sensing Function & PoE
- Wide Operating Temperature -40°C to 70°C
- Safety Standard: UL, cUL, CB, IEC, EN 62368-1

Certifications



High Performance & Power Saving

The DI-1200 supports the 12th generation Core™ i7/i5/i3 U-series (Alder Lake-P) processor based on the Intel® 7 process. Its exceptional processing performance and ultra-low power consumption of just 15W, make it highly suitable for mobile devices limited by battery capacity.

15 Watts

Low Power Consumption



Smaller than A5

The DI-1200 has a footprint smaller than a sheet of A5 paper, with dimensions of only 203 x 142 x 66.8 mm. It is ideal for mobile devices such as AGVs and AMRs, tight spaces in vehicles, or small cabinets in factories.

High-speed I/O

The DI-1200 offers a range of high-speed I/O, including LAN (10GbE, 2.5GbE, 1GbE), USB 3.2 (10Gbps, 5Gbps), USB 2.0, and more, making data and image transmission faster and allowing easy connection to various high-speed devices.





Comprehensive Wireless Options

The DI-1200 has one M.2 Key E slot and one M.2 Key B slot, supporting a full range of wireless transmission options, including GSM, GNSS, Wi-Fi, and Bluetooth. It also supports the Intel CNVi module, meeting diverse transmission needs.

Quick Hard Drive Removal

Mobile devices must allow quick access to data. The DI-1200 features a hot-swappable 2.5-inch SATA HDD/SSD slot in the front panel of the chassis, making it easy to remove the hard drive and access the data on it.



Secure & Rugged

The DI-1200 showcases its ruggedness and industrial-grade protections through multiple industry certifications. It complies with industrial EMC standards (IEC 61000-6-2 and IEC 61000-6-4), ensuring reliable operation in external electromagnetic interference from surrounding devices. The DI-1200 also meets the U.S. military standard, MIL-STD-810H, ensuring stable operation under extreme shock and vibration conditions.

Specifications

Model Name	DI-1200
System	
Processor	<ul style="list-style-type: none"> Onboard 12th Intel® Alder Lake-P U-Series CPU: <ul style="list-style-type: none"> Intel® Core™ i7-1265UE 10 Cores Up to 4.70 GHz, TDP 15W Intel® Core™ i5-1245UE 10 Cores Up to 4.40 GHz, TDP 15W Intel® Core™ i3-1215UE 6 Cores Up to 4.40 GHz, TDP 15W
Memory	<ul style="list-style-type: none"> 1x DDR5 SO-DIMM Socket, Supports Un-buffered and non-ECC Type, Up to 32GB
BIOS	<ul style="list-style-type: none"> AMI BIOS
Graphics	
Graphics Engine	<ul style="list-style-type: none"> Integrated Intel® Iris® Xe Graphics: Core™ i7-1265UE, i5-1245UE Integrated Intel® UHD Graphics: Core™ i3-1215UE
Maximum Display Output	<ul style="list-style-type: none"> Supports Quad Independent Display
HDMI	<ul style="list-style-type: none"> 1x HDMI Connector (3840 x 2160@60Hz)
DP	<ul style="list-style-type: none"> 2x DisplayPort Connector (3840 x 2160@60Hz)
CMI Display	<ul style="list-style-type: none"> 1x CMI Interface for Optional CMI-DP/CMI-HDMI/CMI-VGA Module Expansion
Audio	
Audio Codec	Realtek® ALC888, High Definition Audio
Line-out	<ul style="list-style-type: none"> 1x Line-out, Phone Jack 3.5mm
Mic-in	<ul style="list-style-type: none"> 1x Mic-in, Phone Jack 3.5mm
I/O	
LAN	<ul style="list-style-type: none"> 2x 2.5 GbE LAN, RJ45 <ul style="list-style-type: none"> GbE1: Intel® I225 GbE2: Intel® I225
COM	<ul style="list-style-type: none"> 2x RS-232/422/485 with Auto Flow Control (Supports 5V/12V), DB9
USB	<ul style="list-style-type: none"> 1 x USB 3.2 Gen2x1 (10Gbps), Type A 2 x USB 3.2 Gen1x1 (5Gbps), Type A 3 x USB 2.0 (480Mbps), Type A
Storage	
SSD/HDD	<ul style="list-style-type: none"> 1x 2.5" SATA HDD/SSD Bay (SATA 3.0)
M.2 SSD	<ul style="list-style-type: none"> 1 x M.2 SSD shared by M.2 Key B Type 3052 Socket
RAID	<ul style="list-style-type: none"> Support RAID 0/1
Expansion	
M.2 Key E Socket	<ul style="list-style-type: none"> 1x M.2 Key E Type 2230 Socket (PCIe Gen 3x1 / USB2.0), Support Wireless/Intel CNVi Module Expansion * The maximum height of the M.2 Key E add-on card is limited to 6.7mm.
M.2 Key B Socket	<ul style="list-style-type: none"> 1x M.2 Key B Type 3042/3052 Socket (PCIe Gen 3x1 / USB3.2 Gen2 x1 / USB2.0 / SATA), Support 5G/Storage/Add-on Card Expansion * The maximum height of the M.2 Key B add-on card varies depending on the installed CMI module. Please refer to the manual for detailed information.
SIM Socket	<ul style="list-style-type: none"> 2 x Front Accessible SIM Socket
CMI (Combined Multiple I/O) Interface	<ul style="list-style-type: none"> 1x CMI Interface for optional CMI-LAN Module Expansion 1x CMI Interface for optional CMI-Display / CMI-COM / CMI-DIO Module Expansion
CFM (Control Function Module) Interface	<ul style="list-style-type: none"> 1x CFM IGN Interface for optional CFM-IGN Module Expansion

Other Function	
External FAN Connector	• 1x External FAN Connector, 4-pin Terminal Block (Support Smart Fan by BIOS)
Clear CMOS Switch	• 1x Clear CMOS Switch
Reset Button	• 1x Reset Button
Instant Reboot	• Support 0.2sec Instant Reboot Technology
Watchdog Timer	• Software Programmable Supports 256 Levels System Reset
Power	
Power Button	• 1x ATX Power On/Off Button
Power Mode Switch	• 1x AT/ATX Mode Switch
Power Input	• 9 - 48VDC, 3-pin Terminal Block
Remote Power On/Off	• 1x Remote Power On/Off, 2-pin Terminal Block
Remote Power LED	• 1x Remote Power LED, 2-pin Terminal Block
Physical	
Dimension (W x D x H)	• 203 x 142 x 66.8 mm
Weight Information	• 1.8 KG
Mechanical Construction	• Extruded Aluminum with Heavy Duty Metal
Mounting	• Wall / Side / DIN-RAIL / VESA Mount
Physical Design	<ul style="list-style-type: none"> • Fanless Design • Cableless Design • Jumper-less Design • Unibody Design
Reliability & Protection	
Reverse Power Input	• Yes
Over Voltage Protection	<ul style="list-style-type: none"> • Protection Range: 51~58V • Protection Type: shut down operating voltage, re-power on at the preset level to recover
Over Current Protection	• 15A
CMOS Battery Backup	• SuperCap Integrated for CMOS Battery Maintenance-free Operation
MTBF	• 486,235 Hours - Database: Telcordia SR-332 Issue3, Method 1, Case 3
Operating System	
Windows	• Windows®11, Windows®10
Linux	• Ubuntu 22.04
Environment	
Operating Temperature	<ul style="list-style-type: none"> • -40°C to 70°C - PassMark Burn-In Test: 100% CPU, 2D/3D Graphics (without thermal throttling) - With extended temperature peripherals; Ambient with air flow - According to IEC60068-2-1, IEC60068-2-2, IEC60068-2-14
Storage Temperature	• -40°C to 70°C
Relative Humidity	• 95%RH @ 70°C (non-Condensing)
Shock	• MIL-STD-810H
Vibration	• MIL-STD-810H

EMC	<ul style="list-style-type: none"> • CE, UKCA, FCC, ICES-003 Class A • EN IEC 61000-6-4 / EN IEC 61000-6-2 (24VDC Input Only) • EN 50155 (EN 50121-3-2 Only) • E-mark (Pending)
EMI	<ul style="list-style-type: none"> • CISPR 32 Conducted & Radiated: Class A • EN/BS EN 50121-3-2 Conducted & Radiated: Class A • EN/BS EN IEC 61000-3-2 Harmonic current emissions: Class A • EN/BS EN 61000-3-3 Voltage fluctuations & flicker • FCC 47 CFR Part 15B, ICES-003 Conducted & Radiated: Class A
EMS	<ul style="list-style-type: none"> • EN/IEC 61000-4-2 ESD: Contact: 6 kV; Air: 8 kV • EN/IEC 61000-4-3 RS: 80 MHz to 1000 MHz: 20 V/m • EN/IEC 61000-4-4 EFT: AC Power: 2 kV; DC Power: 2 kV; Signal: 2 kV • EN/IEC 61000-4-5 Surges: AC Power: 2 kV; Signal: 1 kV • EN/IEC 61000-4-6 CS: 10V (**Compliant with the standard when utilizing shielded cable.) • EN/IEC 61000-4-8 PFMF: 50 Hz, 30A/m • EN/IEC 61000-4-11 Voltage Dips & Voltage Interruptions: 1 cycles at 60 Hz
Safety	<p>UL, cUL, CB, IEC, EN 62368-1</p>

External Layout

Front I/O

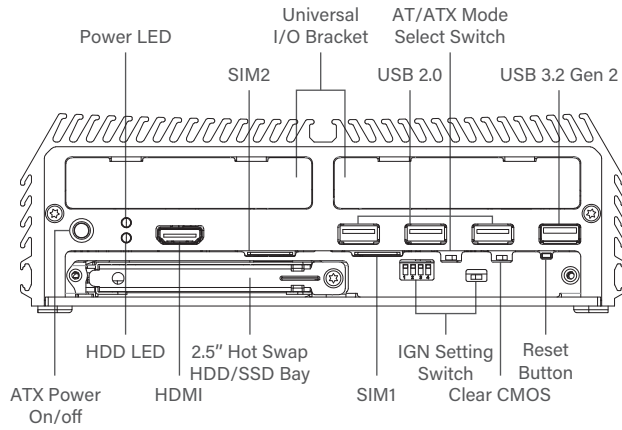

Rear I/O

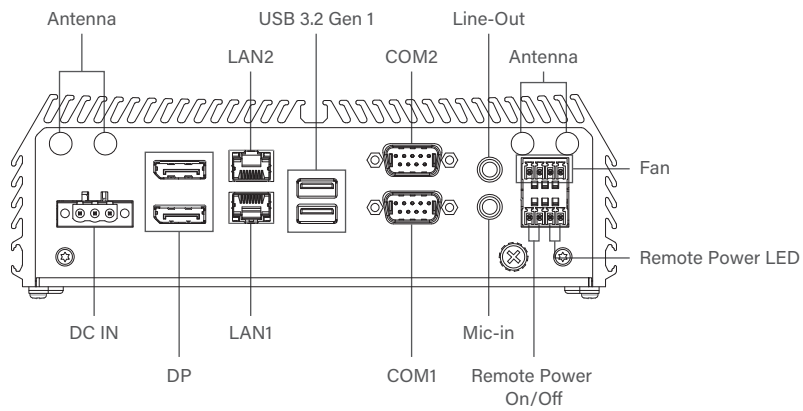

Dimensions

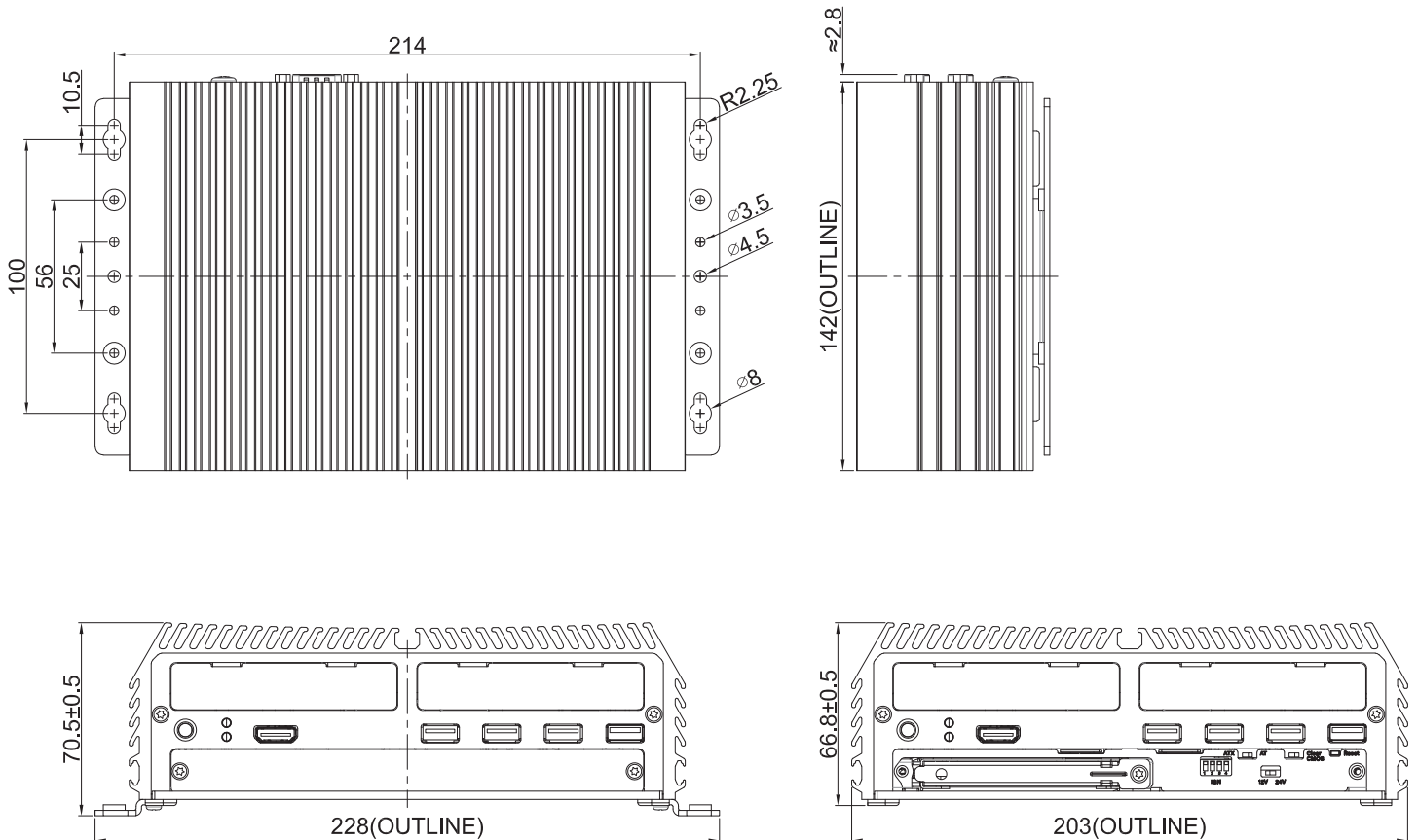

Unit: mm

Ordering Information

Available Models

Model No.	Description
DI-1200-i7-R10	12th Generation Intel Core i7-1265UE High Performance, Compact and Modular Rugged Embedded Computer
DI-1200-i5-R10	12th Generation Intel Core i5-1245UE High Performance, Compact and Modular Rugged Embedded Computer
DI-1200-i3-R10	12th Generation Intel Core i3-1215UE High Performance, Compact and Modular Rugged Embedded Computer

Package Checklist

• DI-1200 Embedded Computer x1	• Power Terminal Block Connector x 1
• CPU Thermal Pad x1	• Remote Power On/Off + Remote Power LED Connector x 1
• Screw Pack x 1	• Fan Terminal Block Connector x 1
• Wall Mounting Kit x 1	• M.2 Key B Type 3052 to 3042 Adapter Bracket x 1







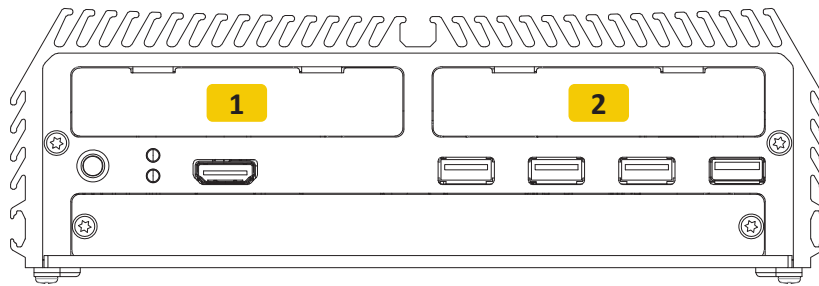

Optional Modules and Accessories

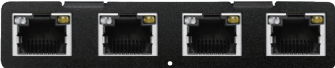
Model No.	Description
CFM-IGN102	CFM Module with Power Ignition Sensing Control Function, 12V/24V Selectable
CFM-PoE06-R10	CFM Module with PoE Function, Individual Port 25.5W
CMI-LAN01-R12	CMI Module with 4x RJ45 Intel I210 GbE LAN Ports
CMI-M12LAN01-R12	CMI Module with 4 x M12 Intel I210 GbE LAN Ports
CMI-XM12LAN01-R10	CMI Module with M12 X-Coded Connector, 4x Intel I210 GbE LAN Ports
CMI-10GLAN04-R10	CMI Module with 2x Intel X550 10GbE LAN Ports
CMI-VGA02-R10	CMI Module with 1x VGA Port
CMI-HD04-R10	CMI Module with 1x HDMI Port
CMI-DP02-R10	CMI Module with 1x DisplayPort
CMI-DIO05-R10	CMI Module with 16DIO (8in 8out)
CMI-COM05-R10	CMI Module with 2x RS232/422/485 (Support 5V/12V)
UB1503-R11	Universal Bracket with 2x DB9 Cutout
UB1506-R10	Universal Bracket with DisplayPort Cutout
UB1508-R10	Universal Bracket with HDMI Cutout
UB1510-R11	Universal Bracket with 4x M12 Cutout
UB1512-R11	Universal Bracket with 4x RJ45 Cutout for CMI-LAN Expansion
UB1516-R10	Universal Bracket with VGA Cutout
UB1518-R10	Universal Bracket with DIO Cutout
UB1528-R11	Universal Bracket with 2x RJ45 Cutout for CMI-10GLAN Expansion
DINRAIL-R10	Diamond series DIN-RAIL Mount Kit

Model No.	Description
FAN-EX103	External Fan with 4pin Terminal Block Plug and Mounting Bracket, Support Smart Fan (*External fan must be installed when using CFM-PoE module)
SIDE01	DI Series Side Mount Kit
GST60A12-CIN1	Adapter AC/DC 12V 5A 60W with 3pin Terminal Block Plug and Tubes, Level VI
GST120A24-CIN	Adapter AC/DC 24V 5A 120W with 3pin Terminal Block Plug and Tubes, Level VI
GST220A24-CIN	Adapter AC/DC 24V 9.2A 220W with 3pin Terminal Block Plug and Tubes, Level VI

Optional Module Configuration



Model No.	Description	1	2
CMI-LAN01-R12/UB1512-R11 	CMI Module with 4x Intel I210 GbE LAN, RJ45 Port / Universal Bracket with 4x RJ45 Cutout for CMI-LAN Expansion	--	V
CMI-M12LAN01-R12/UB1510-R11 	CMI Module with M12 Connector, 4x Intel I210 GbE LAN Ports / Universal Bracket with 4x M12 Cutout	--	V
CMI-XM12LAN01-R10/UB1510-R11 	CMI Module with M12 X-Coded Connector, 4x Intel I210 GbE LAN Ports / Universal Bracket with 4x M12 Cutout	--	V
CMI-10GLAN04-R10/UB1528-R11 	CMI Module with 2x Intel X550 10GbE LAN, RJ45 Port / 1x Universal Bracket with 2x RJ45 Cutout for CMI-10GLAN Expansion	--	V
CMI-VGA02/UB1516-R10 	CMI Module with 1x VGA Port/Universal Bracket with VGA Cutout	V	--
CMI-HD04/UB1508-R10 	CMI Module with 1x HDMI Port/Universal Bracket with HDMI Cutout	V	--
CMI-DP02/UB1506-R10 	CMI Module with 1x DisplayPort/Universal Bracket with DisplayPort Cutout	V	--
CMI-COM05-R10/UB1503-R11 	CMI Module with 2x RS232/422/485 Ports (Support 5V/12V) / 1x Universal Bracket with 2x DB9 Cutout	V	--
CMI-DIO05-R10 / UB1518-R10 	CMI Module with 16DIO (8in 8out) / 1x Universal Bracket with DIO Cutout	V	--

V : Compatible